

USER MANUAL



Thank you for choosing Better Bathrooms.
Please read this manual before installing your product
and keep for future reference.

**better
bathrooms**

PRODUCT NAME-MATIRA SEMI FLUTED WALK IN SCREEN

PRODUCT CODE- MATWI800CH MATWI900CH MATWI1000CH

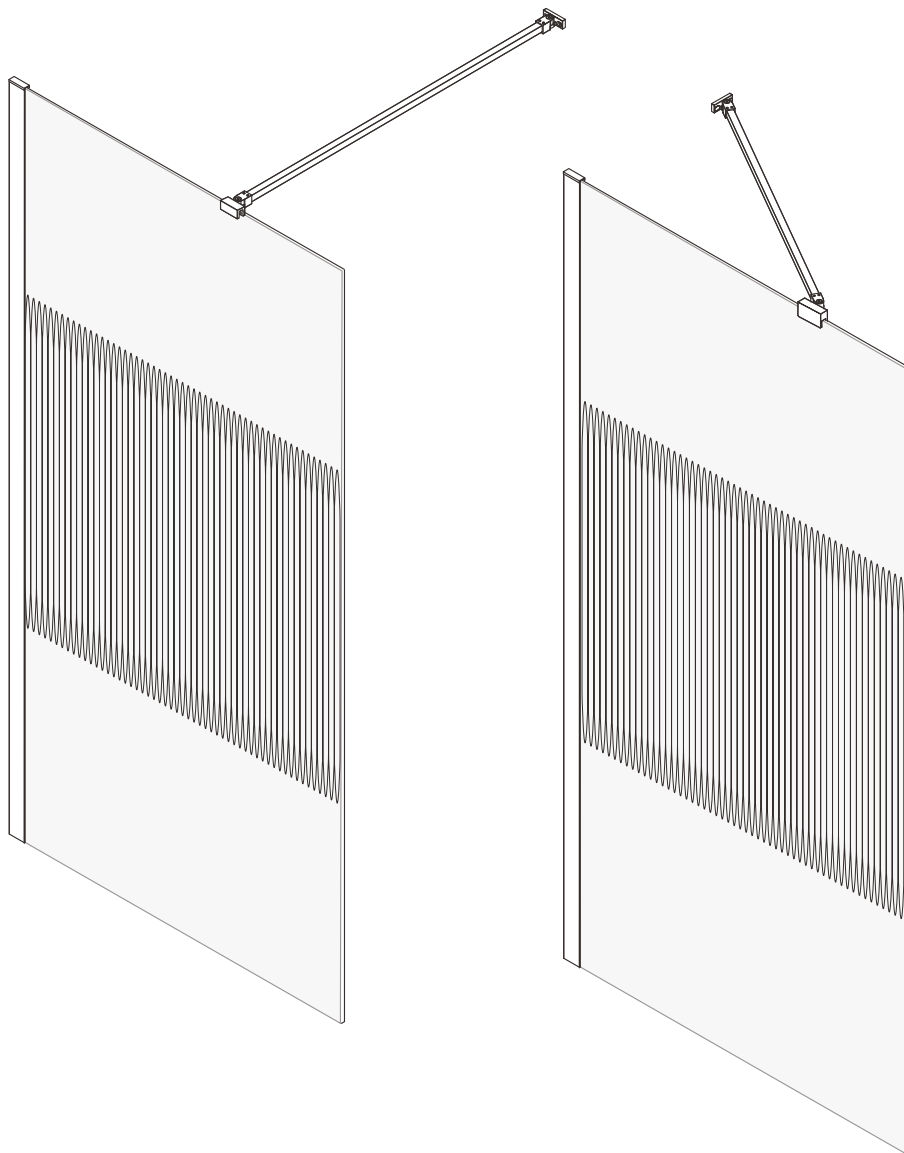

- **Multi-person assembly**
- **Tools required**
- **We always recommend using professional tradespeople to install your product**

Congratulations on your purchase

And welcome to our growing gang of savvy shoppers

We're on a mission to bring you extraordinary bathroom products, for less. From modern to traditional style ceramics, plus the gorgeous fixtures, fittings and furniture to match. So, you can fall in love with your space every single day.

As one of the UK's largest independent bathroom stores, we've received countless awards; including the National Business Awards UK, the Digital Entrepreneur Awards and being placed on The Sunday Times Fast Track 100.

We hope your new product goes above and beyond your expectations. However, should any problems occur, please:

- log in to your account and contact our customer services team via your self-serve portal – betterbathrooms.com/CustomerAccount/Login
- contact us via betterbathrooms.com/content/contact-us

Important information

- Please read these instructions thoroughly and retain for future reference
- Always check for pipes and cables before drilling

CAUTION

- To prevent leaks, silicone must be applied on the outside of the shower and not on the inside
- Read all instruction carefully before starting the installation
- Save this manual for future reference

Contents

- PART LIST-----PAGE 04
- PREPARATION & TOOL REQUIRED-----PAGE 05
- INSTALLATION-----PAGE 06
- CONTINUE-----PAGE 07

PARTS LIST

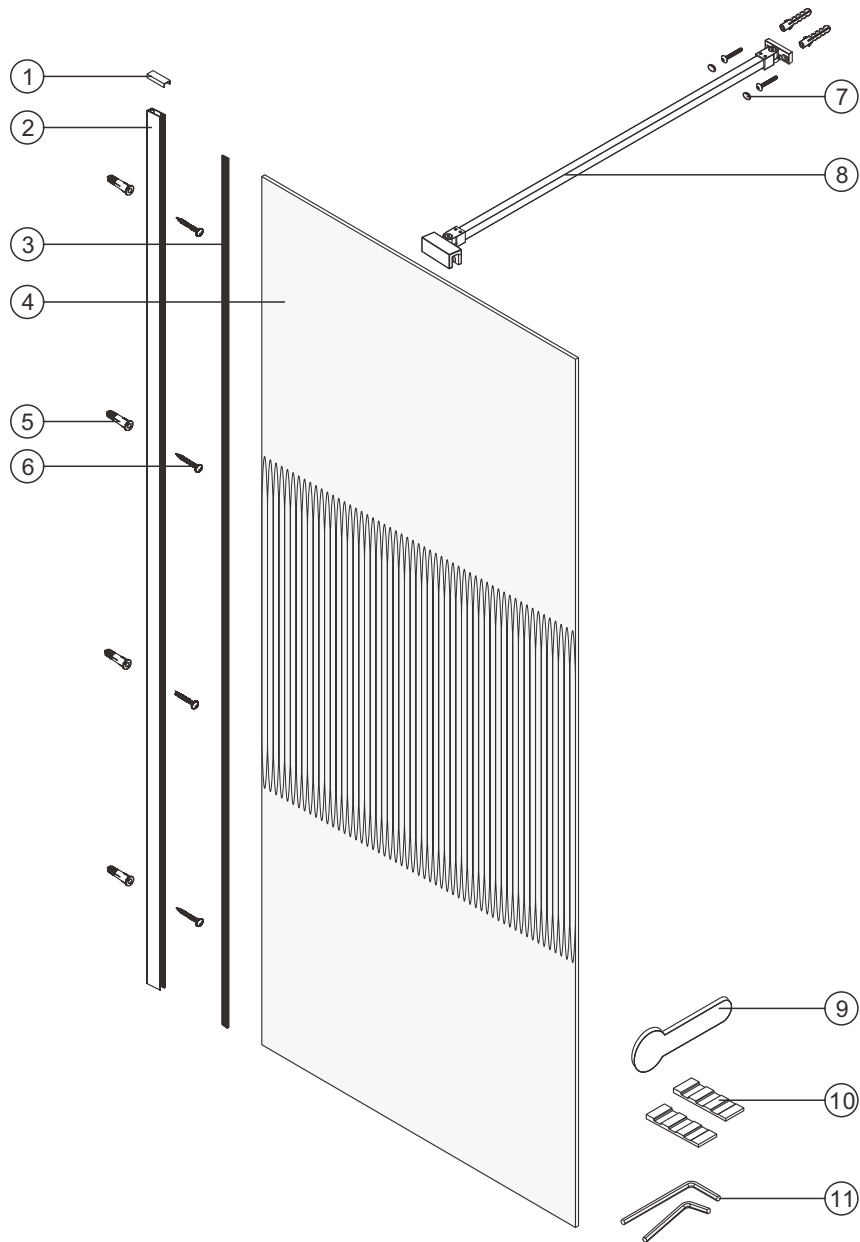

NO	Qty	Description	NO	Qty	Description
1	1	Cover Cap	7	2	Screw cap
2	1	Wall Channel	8	1	Bracing bar
3	1	Squeeze gasket	9	1	Squeeze gasket tool
4	1	Glass Screen	10	2	Glass Wedge
5	6	Wall Plug	11	2	Allen key
6	6	Screw ST4X40			

Preparation

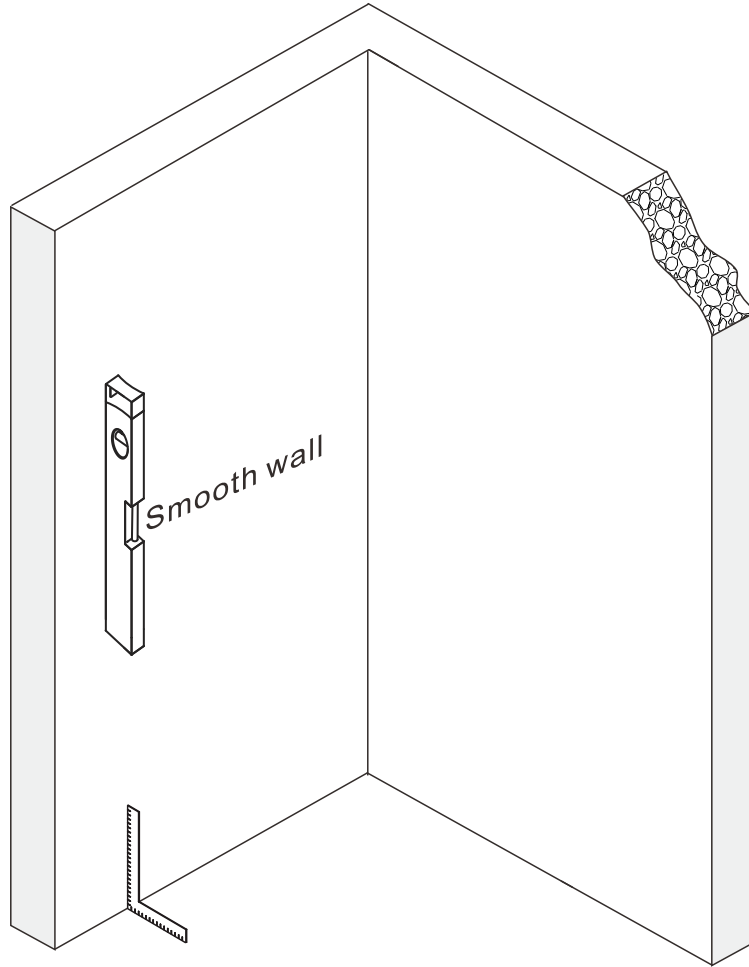

Tools required

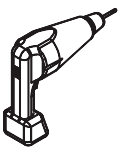

DRILL

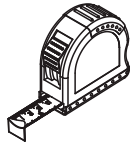

MEASURING TAPE



SILICONE

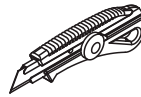

PRECISION KNIFE

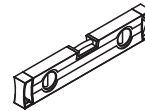

LEVEL

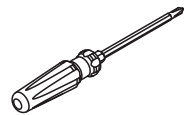

SCREWDR



MALLET



SET SQUARE



PENCIL



DRILL BITS: 1/8", 3/16" ET 1/4"
*MASONRY DRILL BIT



SCREWS

Installation

A 01

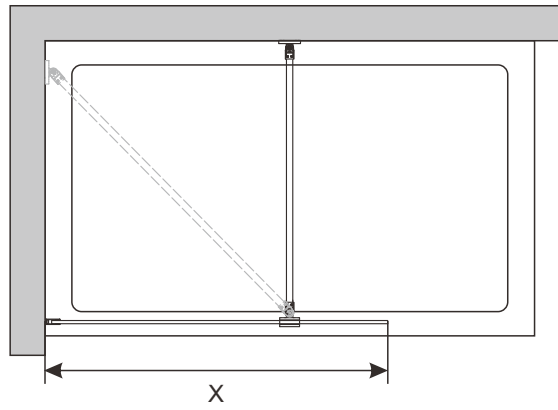

Size	X,mm
800	775~790
900	875~890
1000	985~1000

Continue

A 02

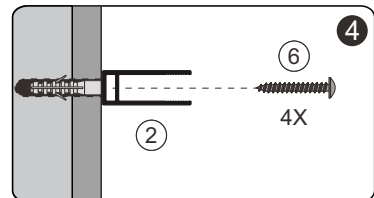
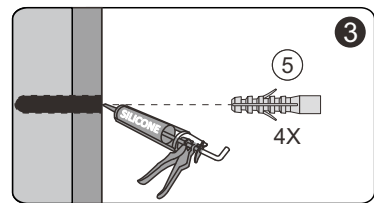
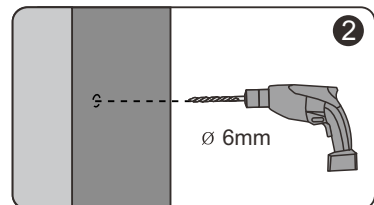
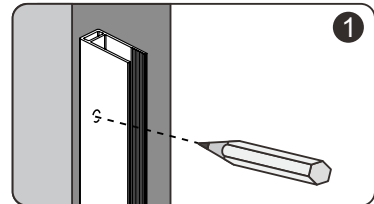
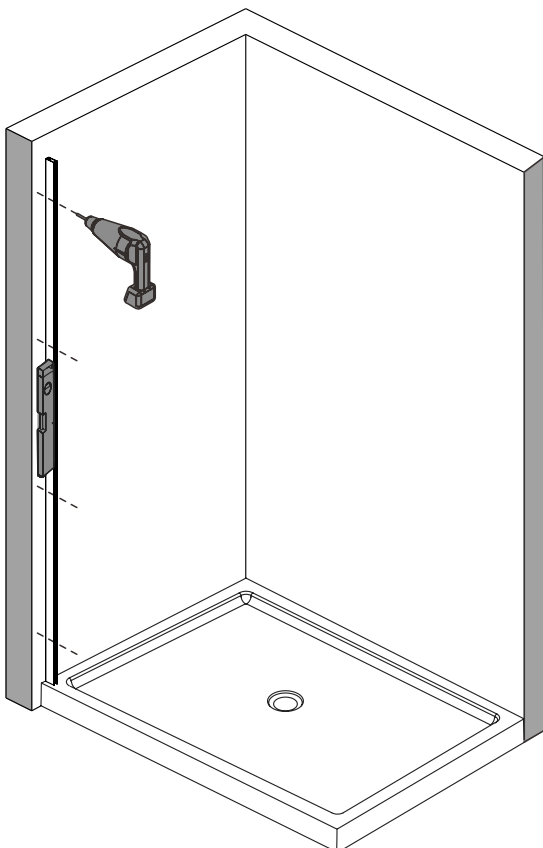

Continue

A 03

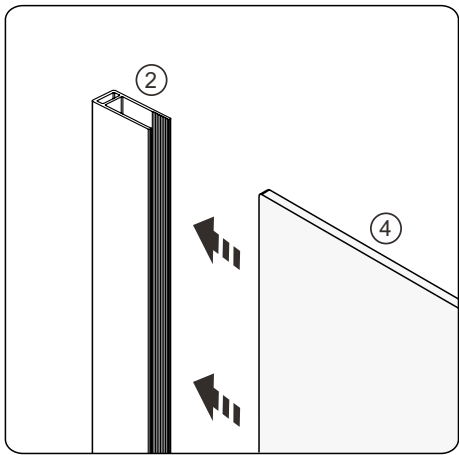
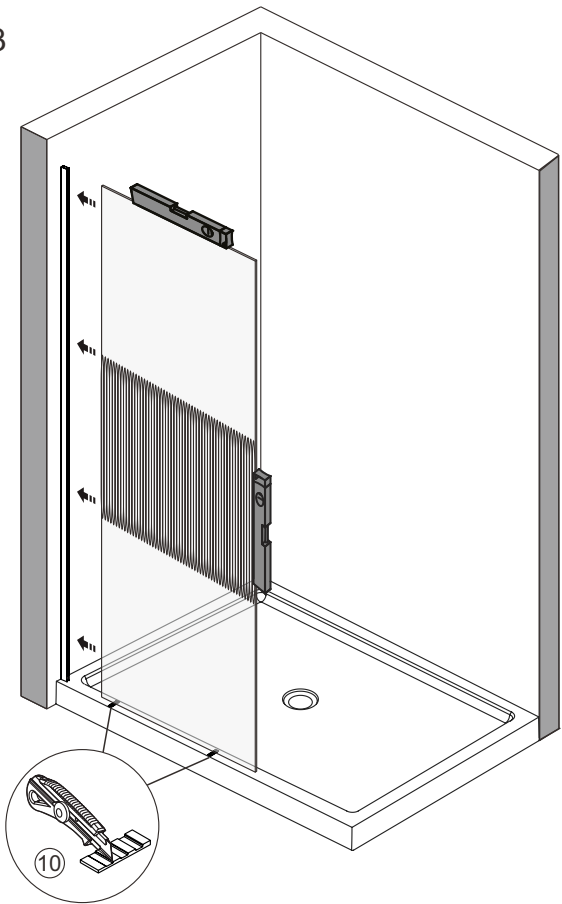

Continue

A 04

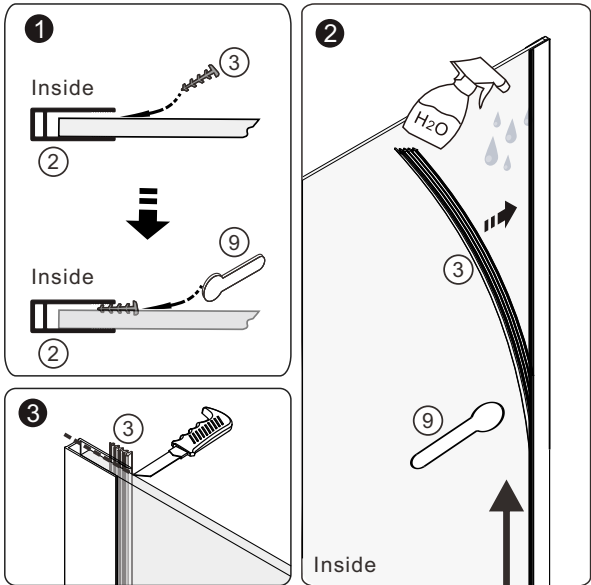
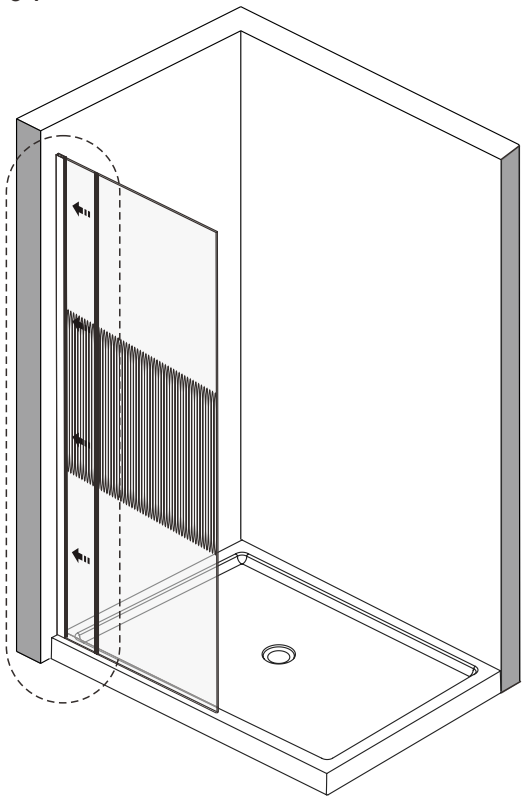

A 05

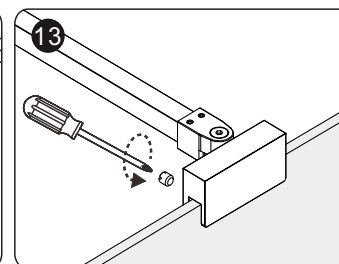
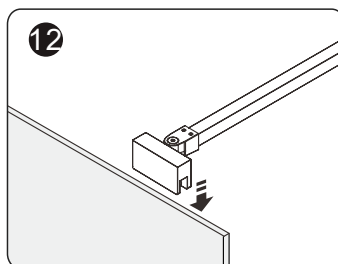
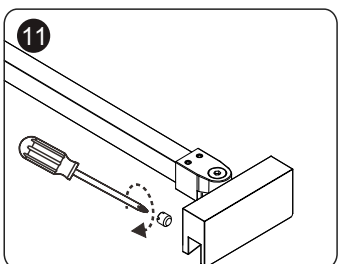
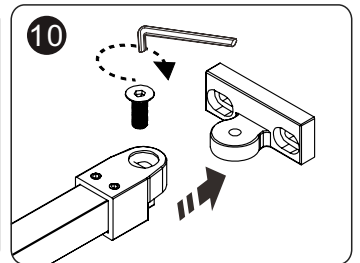
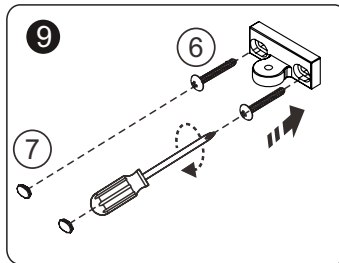
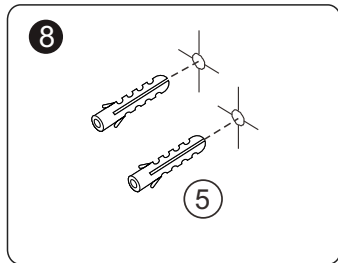
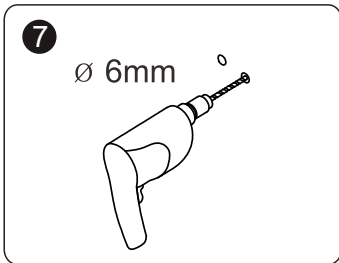
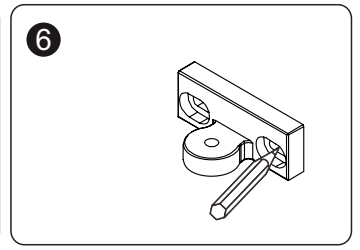
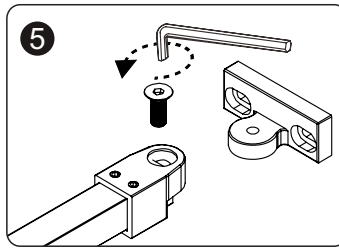
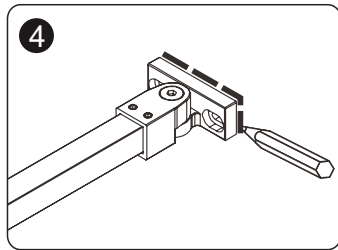
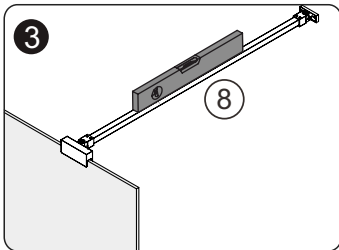
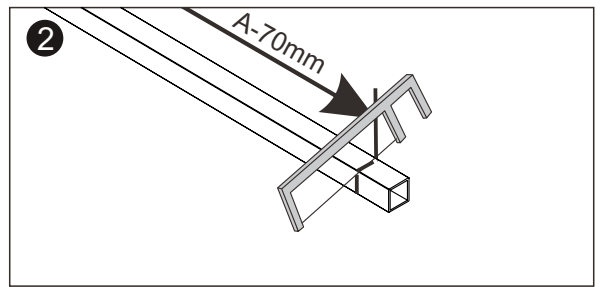
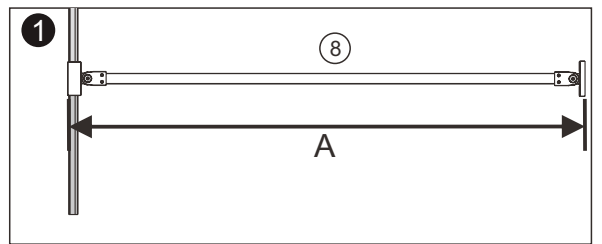
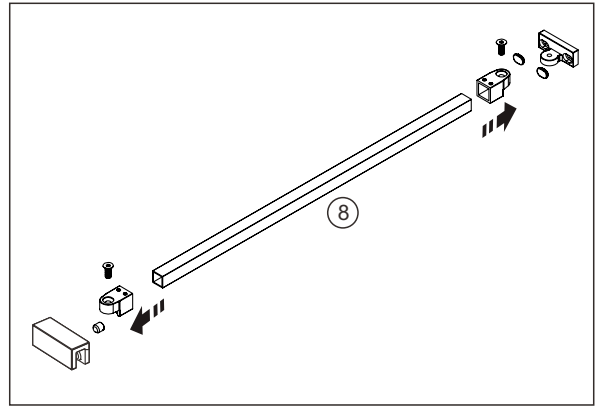
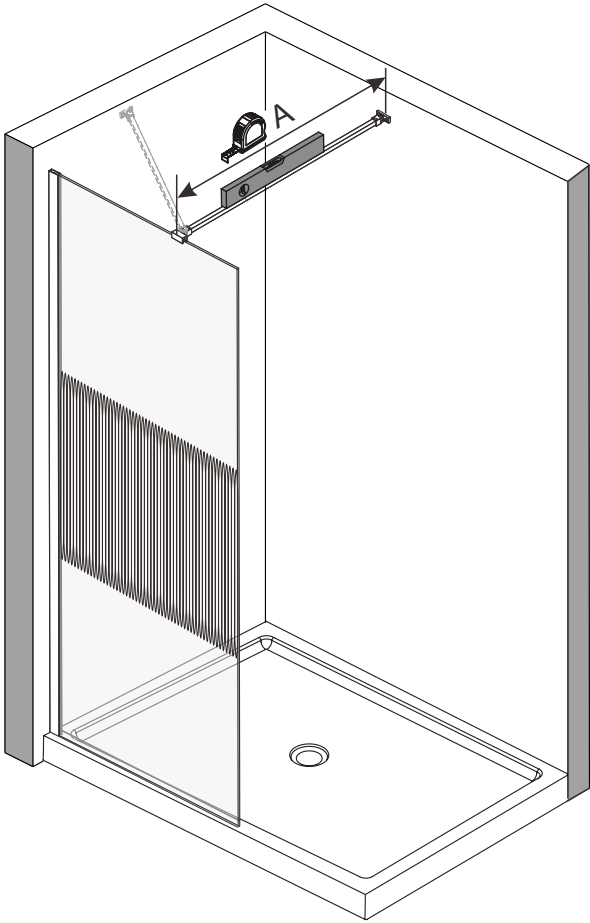

A 06

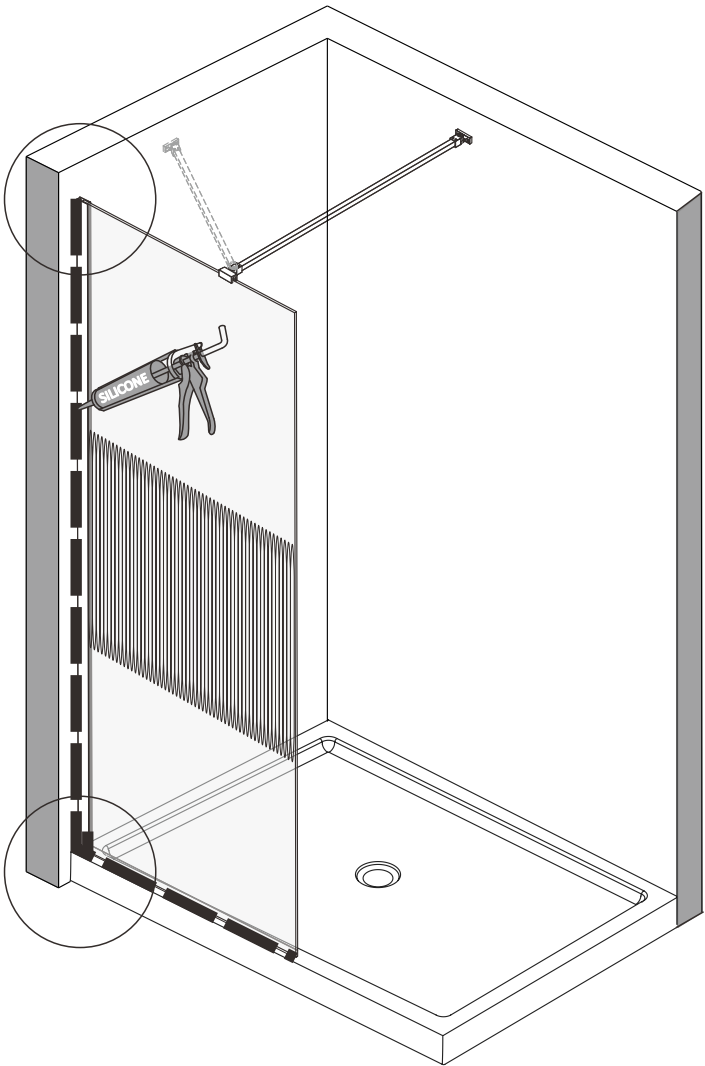
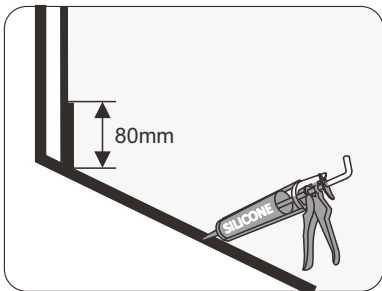
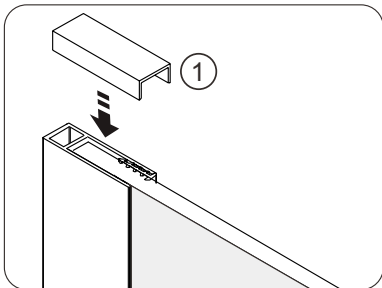

Maintenance & Cleaning

Use a PH-neutral cleaning agent to maintain and clean the surface of your product. Not to use alkaline, solvent, acid and chloric or scrubbing agents.

To maintain the surface of your product, wipe with a clean damp cloth and wipe dry, do not use any abrasive cleaning agents or materials. If any harsh chemicals come into contact with the surface of the product, rinse and wipe clean immediately.

For more information

- visit betterbathrooms.com
- email customerservices@buyitdirect.co.uk
- call 03303903062
- write to Trident Business Park, Neptune Way, Huddersfield, HD2 1UA

**better
bathrooms** 

Part of the BuyItDirect Group